

SEZIONE A-A

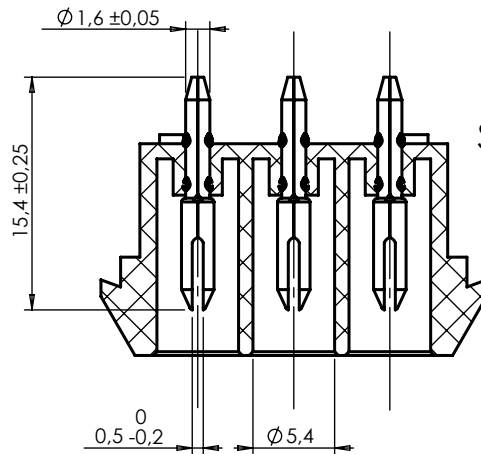

SEZIONE B-B

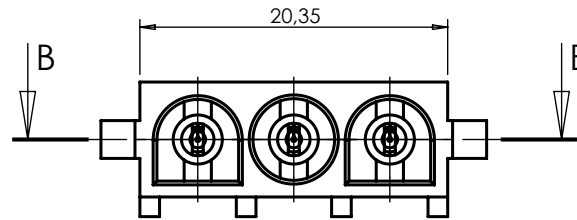
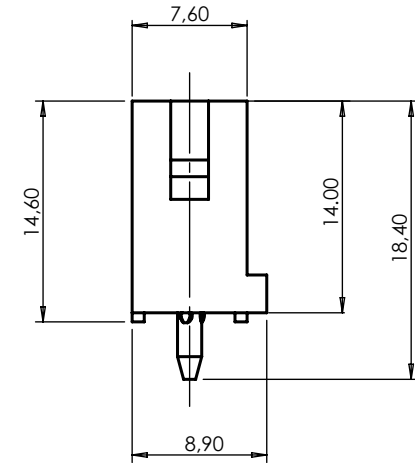
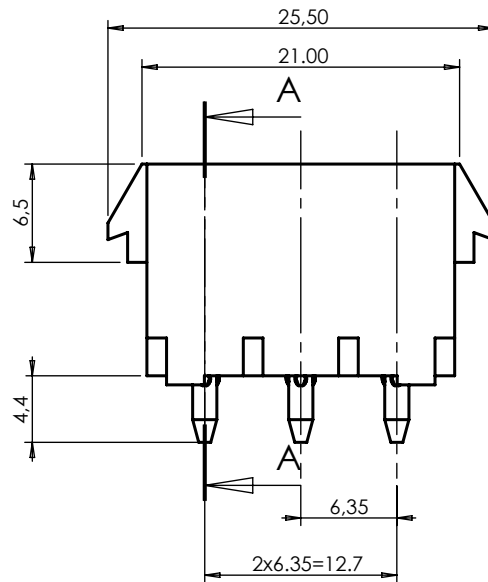
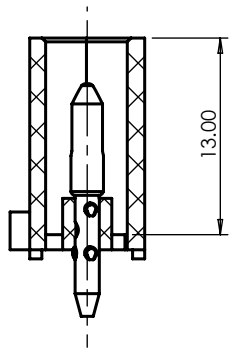
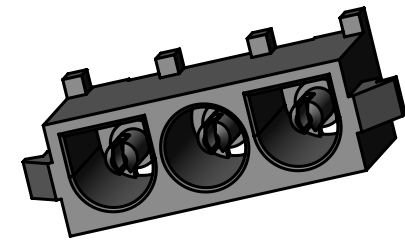

| DIMENSIONS WITHOUT TOLERANCES | | | | | |
|-------------------------------|--------|------|---------------------|------------------------|--|
| A | 0 - 6 | ±0.1 | CS-LK03PCB-M | PA66 UL94 V-2 | |
| | 6 - 30 | ±0.2 | CS-LK03PCB-MV0 | PA6/66 UL94 V-0 | |
| | > 30 | ±0.3 | CS-LK03PCB-MSTY | PA46 UL94 V-2 | |
| | | | CS-LK03PCB-MV0750NF | PA66 UL94 V-0 GWIT 775 | |
| | | | CS-LK03PCB-M-G | PA6 UL94 V-2 GWIT 775 | |
| | | | PART NUMBER | MATERIAL | |

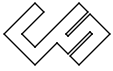
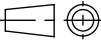
| | | | |
|---|--|------------|---|
| 1 | Disegno portato a CAD | | 27-07-2015 |
| INDEX | MODIFICATION | | DATE |
|  <p>CS S.r.l. 20063 CERNUSCO S/N - VIA COMO, 11 TEL +39.02.9210.7404 - FAX +39.02.9210.0217 http://www.csconnectors.com - e-mail: info@csconnectors.com</p> | | |  |
| CHECKED BY | | DATE | DESIGN UNITS |
| Stefano Galimberti | | 27-07-2015 | METRIC |
| DRAWN BY | | DATE | WEIGHT |
| Luca Viscardi | | 27-07-2015 | 1.49 |
| CAD REFER | | SIZE | SCALE |
| Y:\dis\cs\lk\03vie\pcb\ | | A4 | 2:1 |
| INDEX 0 | | 06-03-2002 | |
| BASE CODE | DESCRIPTION | | |
| CS-LK03PCB-M | Giunto 3 vie per scheda circuito stampato term. maschio serie lk | | |